



HV1600 R38 WHOLE HOUSE FAN

DUCTLESS



Cools homes up to 2,000 Sq ft

FEATURES

- Quickly circulates up to 1600 CFM* | Cools & ventilates the entire home using fresh outside air
- Energy efficient & maintenance-free
- Mechanical self-sealing doors with R38 insulation value
Also available in R50 insulation
- Easy to install both horizontally and vertically
- Fits 16" - 24" on-center joists | No joist-cutting required
- Controlled by remote, SPST wall switch, or spring-wound non-digital timer (*Hardwired configuration is optional. Switch and timer not included with fan purchase*)**
- Standard 3-year limited warranty with optional extended warranty

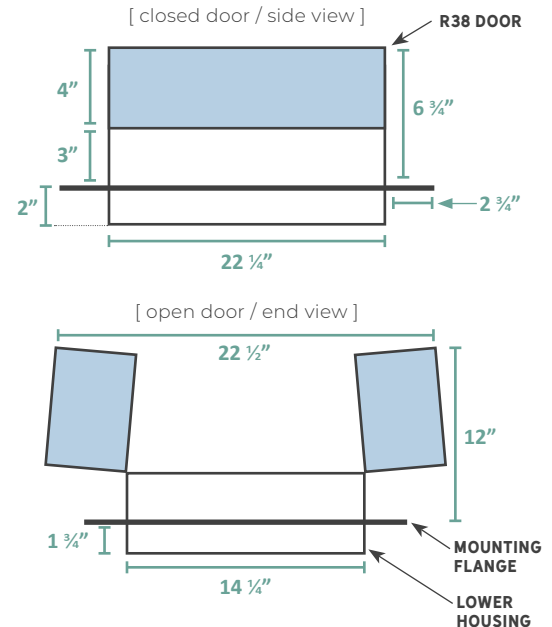

SPECS

AIRFLOW (CFM): HIGH SPEED 1600 LOW 1150

ELECTRICAL REQUIREMENTS: 115/120 VAC, 60HZ

POWER USAGE (WATTS): HIGH SPEED 230 W LOW 207 W

DOORS INSULATION VALUE: R38

ROUGH OPENING: 14 1/2" x 22 1/2"

INTERIOR GRILLE: 15 3/4" x 25 3/4" / WHITE METAL

OPERATION: 2 SPEEDS / 30 SEC DOOR DELAY BEFORE FAN STARTS

ATTIC VENTILATION: REQUIRED 2.13 SQ FT NET FREE AREA RECOMMENDED 2.8 SQ FT NET FREE AREA

WEIGHT: UNIT 26 lbs SHIPPING 40 lbs

PURCHASE INCLUDES: (1) HV1600, (1) HORIZONTAL GRILLE, (1) REMOTE CONTROL

OPTIONAL ACCESORIES: VERTICAL GRILLE, "MUFFLER" ACOUSTIC PLENUM BOX



*CFM rates were measured in a controlled test environment. Results will vary due to building construction.

**All other controls will void the product warranty.